

A man in a light-colored jacket is looking at his smartphone in a city at night. The background is filled with blurred lights and a large, semi-transparent circular graphic on the left side of the image.

padtec



padtec.com

**Updated in January/2026*



Padtec goes where no one else goes_

by bringing high-capacity connections to life.
From Brazil to the Americas, from the smallest
to the largest business, we are where you are.

padtec.com





With a history that spans more than 20 years, _

we are honored to be a Brazilian multinational company that works alongside our customers to offer services that bring people together.

We live and breathe technology_

using our expertise to design new futures. We leverage connections and create new realities in a world that does not stop evolving.



Padtec by the numbers

R\$ 291.9 mi
Net revenue (2025)



R\$ 42.7 mi
EBITDA (2025)



PDTC3
B3



500+
Employees
(December/2025)



Headquarters

Campinas, São Paulo (Brazil)

Rua James Clerk Maxwell, 507 – Parque Tecnológico
Techno Park – Quadra 09678-I – Lote 007
Tel.: +55 19 2104-9600



CEO

Carlos Raimar Schoeninger



National offices

São Paulo – Rio de Janeiro – Brasília – Fortaleza – Curitiba



International offices

Argentina – Chile – Colômbia – USA – Peru – Mexico



Mexico



EUA



Colômbia



Peru



Fortaleza



Brasília



Campinas



Rio de Janeiro



São Paulo



Curitiba



Chile



Argentina



Leaders

The people that drive our connections



CEO
**Carlos Raimar
Schoeninger_**

Master in Administration from Fundação Getúlio Vargas (FGV), with over 20 years of experience in executive positions in various sectors.



SALES DIRECTOR
FOR THE NATIONAL
MARKET

**Henrique
Graciosa_**



CFO AND INVESTOR
RELATIONS DIRECTOR

**Leonardo
Chamsin_**



SALES DIRECTOR FOR
THE INTERNATIONAL
MARKET

**Hernán
Yepes_**



PRODUCT
DIRECTOR

**Alexandre
Piovesan_**



GLOBAL SALES
DIRECTOR

**Alessandra
Erthal_**



Values



Exceed expectations

Our bar is set high. We always look ahead, investing in excellent, long lasting and exceptional solutions.



Working together to increase knowledge

In our universe, everything depends on teamwork. We value our collective intelligence, as diverse as the challenges we solve.



Respect people, respect the future

We exist to improve people's lives. Respect, accessibility, honesty, transparency and ethics in relations are our values; to make an increasingly positive impact on the sector is our goal.



Challenge the complexity

Whether it's a new technology or service, special requirements or network performance, or even the analysis of a large volume of information, our industry seems complex – and it is.

But for us, it is an opportunity to take on and overcome challenges.



Create value for everyone

Each part of our ecosystem should benefit from our actions, improve their outcomes, differentiate themselves and retain their customers.

The world connects and both society and the economy win.

In short: we connect Brazil and the world and our shareholders receive the return they deserve.



History



2001

Padtec starts_

as a spin-off from CPQD's optical communication laboratories, manufacturing and supplying long distance DWDM systems.

Padtec acquires important clients_

and begins its expansion throughout Brazil.

2002 - 2006

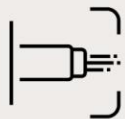

2010 - 2013

It completes a decade of operations_

with more than 100,000 km of backbone networks installed throughout South America and attracts a new investor: BNDESPar, the BNDES' shareholding arm. It also opens its commercial office in the United States.

Padtec connects Brazil and the world_

in the greatest World Cup of all times, performs the Sea Trial of its submarine repeater in the Caribbean Sea and implements a system with sub-fluvial cable in the Rio Negro, in Manaus.Negro, en Manaus.

2014 - 2016



2017 - 2019

Delivers its first deployment of an underwater optical network to Google_

Padtec completes the sale of the subsea systems division and its OTN Switching business unit to important multinationals in the sector.

Padtec completes the merger of its shares into Padtec Holding_

to raise capital on the stock exchange and expand its investments in the development of cutting-edge technology and expansion into new markets. Enters the switches and routers market.

2020 - 2025





Customer portfolio

We've said it before and we'll say it again: from Brazil to the Americas, from the smallest to the biggest business, we're where you are.

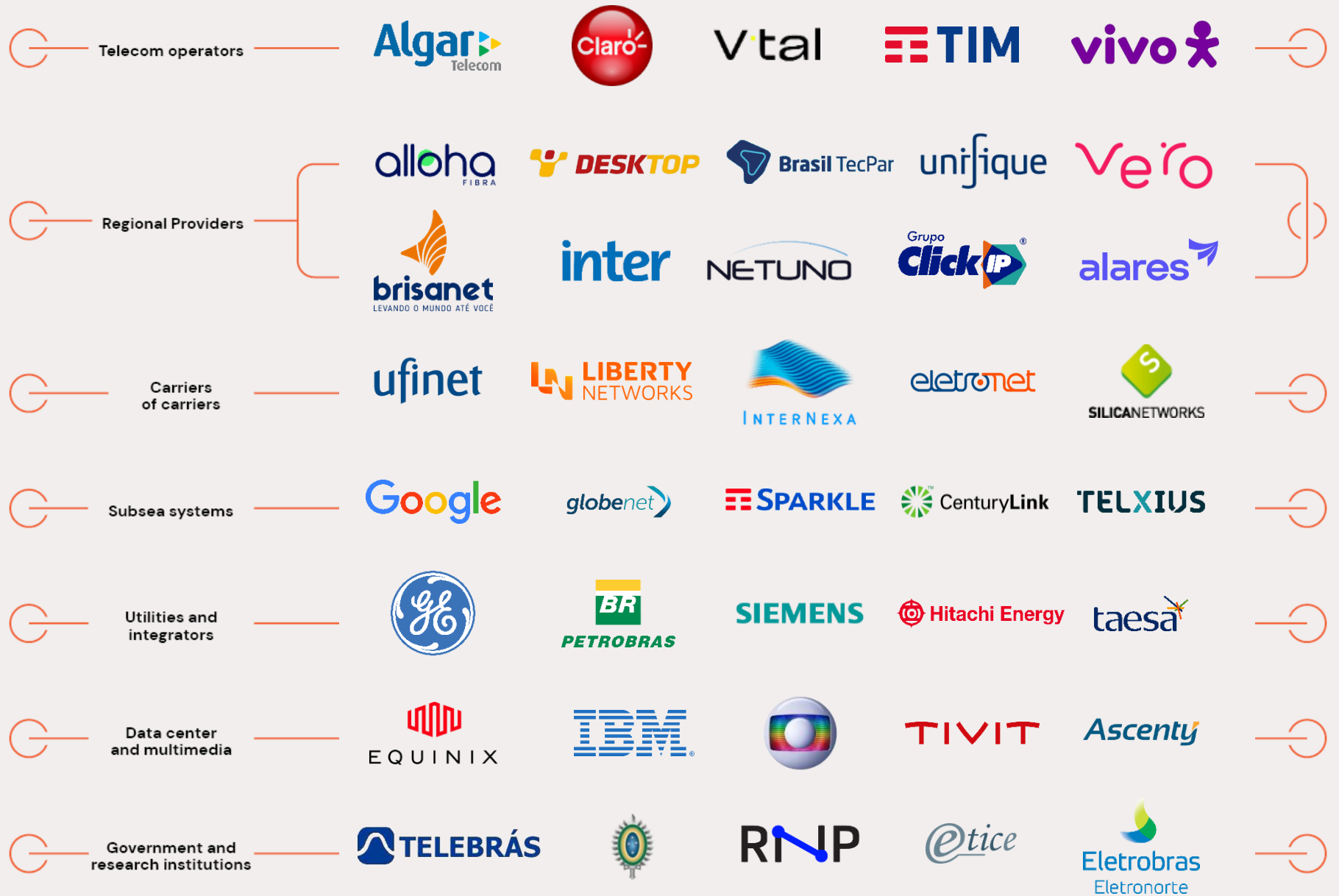

Made by people, for people



500+ 

employees and interns working in person, hybrid or fully remote

370+ 

employees at the company's headquarters in Campinas

140+ 

Employees spread throughout Brazil, Argentina, Colombia, Chile and the USA

86%

is the engagement rate of the company's employees*

55.2%

of employees with college

4.2%

with completed doctorate and master's degrees

21.8%

of the company's employees are engineers

25%

of employees are women

18.6%

of women in leadership positions

Generations**

1%

Baby boomers
(born between 1940 and 1959)

20.5%

Generation X
(born between 1960 and 1979)

64.9%

Generation Y
(born between 1980 and 1999)

13.6%

Generation Z
(born between 2000 and 2010)

* Source: Padtec Climate Survey 2023

** Definition by Sidnei Oliveira

Data from Dec/2025

A man and a woman in business attire are looking at a laptop together in a server room. The man is on the left, wearing a light blue shirt, and the woman is on the right, wearing a dark blue blazer and glasses. They are both smiling. The background is a server room with many racks of servers and lights. The image is framed by a large, dark blue circular graphic.

Business Units

Understand how we create
new realities.



Business units



Products

- LightPad Platform i6400G
- LightPad Max Platform (2.4T)
- DCI Generation Platform (1.2T)
- 400G Standalone
- Switches and Routers
- Enterprise
- Coherent Transceivers
- OTDR Solution



Services

- Network Maintenance
- Network Management
- Characterization
- SPaaS (Spare Part as a Service)
- Fiber Monitoring
- Training



Digital Solutions

- Smart Site
- Smart Workspot
- InovaTEC

Subsea Networks

- River Systems
- Submarine Systems
- Operation and Maintenance of Subsea Networks





Products

Business units

LightPad i6400G Platform

**LightPad i6400G: a platform for
the most diverse solutions**

Our platform delivers a carrier-class solution for high-capacity multi-service transport across diverse network architectures.



Applications

- Terrestrial and submarine backbones
- Metro and aggregation networks
- DCI and SAN extension scenarios

Technologies

- DWDM (*Dense Wavelength Division Multiplexing*)
- ROADM WSS (*Wavelength Selective Switch*)
- OTN (*Optical Transport Network*)
- ODU-XC (*ODU cross-connect*)

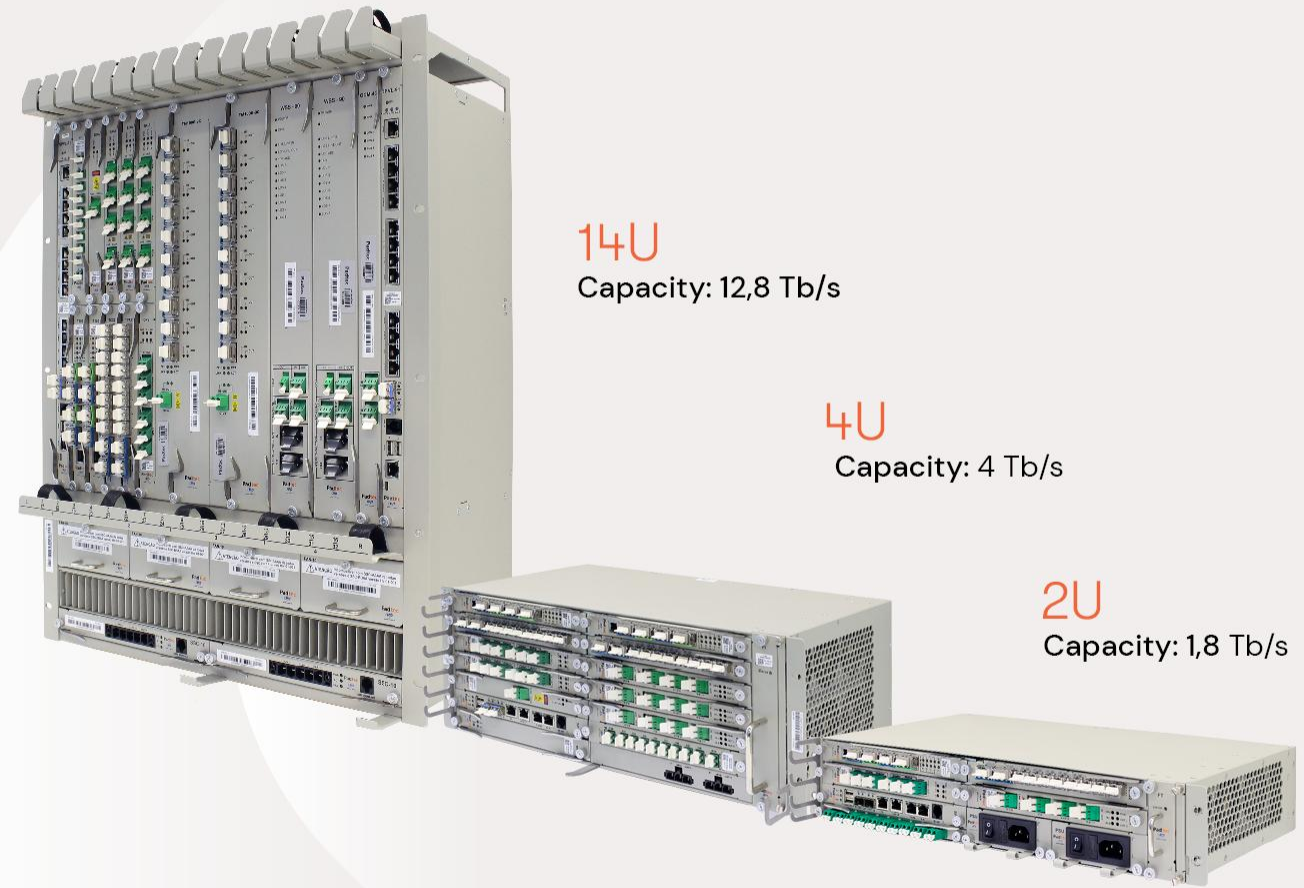



Products

LightPad i6400G Platform

Product family



Muxponder Dual 400G TMD400G

Network Interfaces

- 2x CFP2-DCO 400G
- Rate configurable from 100 Gb/s to 400 Gb/s
- Client Interfaces
- QSFP28 SR or LR
- Up to 8x 100G
- Port activation by license
- 4x100G dual muxponder application
- ALO protection features (Auto Laser Off), Loopback y OSNC



Combiner 200G TCX200G-9A

- Line interfaces
- CFP2-DCO, applications:
 - 1x CFP2 200G
 - 2x CFP2 100G
- Client Interfaces
- QSFP+
- 2x QSFP+/QSFP28 up to 100G
- Protocols: 4x10G/40G/100G
- SFP+ client interfaces
- 12x SFP+ up to 16G

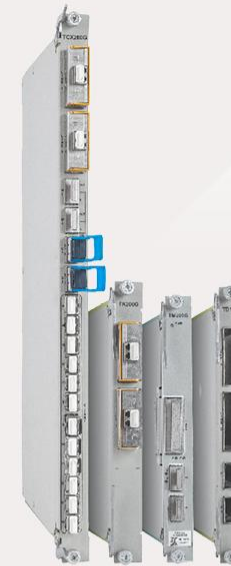

Business units

Linecards

100/200 Gb/s

- Muxponder 200G (2x100G)
- Regenerador 100/200G (2x100G)
- Dual 100G ((2x100G)



Linecards

10Gb/s

Applications

- Dual Terminal
- Protected ring (x-connect)

Operation mode

- 2x OTU2
- 3x OTU1

Functionalities

- OSNC protection (route)
- ALO for use with optical switch



Products

Business units

LightPad i6400G Platform

Passive Solutions

Mux/Demux

Low Loss

- Low loss Mux/Demux developed specifically for this application
- Network design and performance guaranteed by Padtec
- Possibility of using amplifiers for link extension



Mux/Demux

48 channels with and without VOA

Complete portfolio for Add/Drop channels.

Mux/Demux from 4 to 96 channels

- Standalone mechanics
- Options with VOA
- Colorless Options
- 2, 4 and 8 channel OADMS



Passive Box

- Entry solution for DWDM technology
- Colored SFP+ for use directly with switches and routers

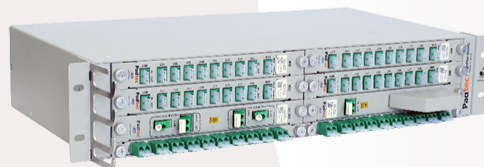

OADM

Optical/Add-Drop/Multiplexer





Products

LightPad i6400G Platform

Amplifiers

High performance, low noise figure



Amplifiers EDFA



Raman and ROPA

C Band EDFA

- 18 dBm family

C+ Band

- EDFA 21 dBm
- Raman 29 dBm
- Hybrid EDFA + Raman

Hybrid R2

- Super compact Hybrid Amplifier with integrated Transmit EDFA, Receive EDFA and Raman stages

Special solutions

- Raman 33 dBm
- ROPA C+
- ROPA optimized for few channels

Business units

Optical switches

OPS-Hx (Optical Protection System)

Characteristics

- Switching time <15 ms
- Route monitoring
- Single and Multimode Models
- One or two switching units on the same module





Products

Business units

LightPad i6400G Platform ROADM



Wavelength Selective Switch WSS9-9A and WSS4-9A

Functionalities

- End-to-end provisioning
- Automatic EQ
- Protection 1+1, 1+R and 1+1+R

Architecture:

- Directed
- Directionless
- Colorless
- FlexGrid

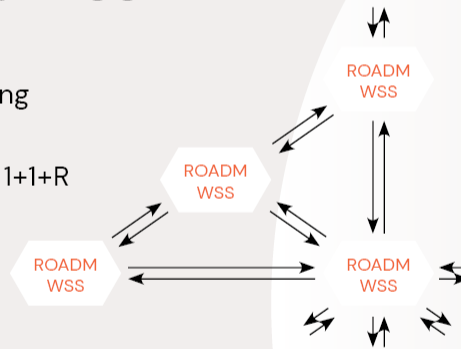

Wavelength Selective Switch WSS2-HA

- 2 degrees
- Characteristics:**
- Ring topology
 - Low insertion loss
 - Embedded OCM
 - Protection and restoration ready



OCM-HR High Resolution - Optical Channel Monitoring

- Power monitoring and OSNR of DWDM channels
- 8 independent monitoring ports
- Compatible with FlexGrid channels
- Applications for networks without WSS or at WSS nodes





Products

Business units

LightPad Max

Double Muxponder 2.4 Tb/s::

- Up to 2x 1.2 Tb/s channels
- Programmable (68 to 138 GBd)



Supervision:

- Ports for DCN, GL and cascading

Lines 2x CIM8:

- 800G
- 1T
- 1,2T

Customers 6x (per Line):

- up to 6x QSFP28
- up to 2x QSFP-DD
- 100G/200G/400G

Energy:

- 2x redundant DC 0/-48V lanes



Removable fans from the rear panel





Products

Business units

DCI Generation Platform

Padtec Muxponders 1200G and 800G

If you have Padtec technology,
capacity is included.

The TM1200G and TM800G muxponders
are ideal for very high capacity applications
in short, medium and long distance DWDM



TM1200G

- Transmission rates from 100 Gb/s to 600 Gb/s
- Configurable modulations: DP-QPSK to DP-64QAM
- Transmission capacity of 38.4Tbps in the C+ Band
- Support for Fine Tuning
- Compatible with MicroMux module
- 27% SD-FEC* for "Ultra High Gain"
- Maximum power consumption: 340W



TM800G

- Transmission rates from 100 Gb/s to 400 Gb/s
- Configurable modulations: DP-QPSK to DP-16QAM
- Transmission capacity of 25.6Tbps in the C+ Band
- Support for Fine Tuning
- Compatible with MicroMux module
- 27% SD-FEC* for "Ultra High Gain"
- Maximum power consumption: 340W



Products

Business units

Dual 400G Transponder

Standalone transponder with up to 400 Gb/s (per optical channel) ideal for point-to-point applications or traditional DWDM solutions

TMD400G-SD

- Standalone mechanics with low rack space requirements (1RU height)
- Low cost coherent solution from 100G to 400G
- Used in single wavelength point-to-point systems
- Traditional DWDM application
- Network interface based on the new 400G ZR standard
- Entry level solution with built-in supervisor

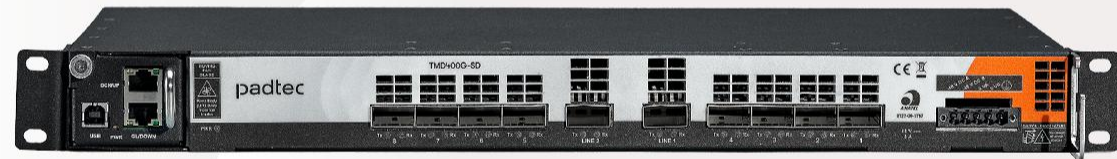



Products

Switch and router platform



Access networks S9510-28DC

Responsible for providing direct connectivity to residential and corporate users, the access infrastructure provided by the partnership between Padtec and **UfiSpace** features open access routers that are temperature resistant, compact and easy to maintain.

- 2 doors 100/400G QSFP-DD
- 2 doors 40/100G QSFP28
- 24 doors SFP28 10/25G
- 800 Gb/s switching capacity

- 1 S9500 Family
- 2 S9600 Family

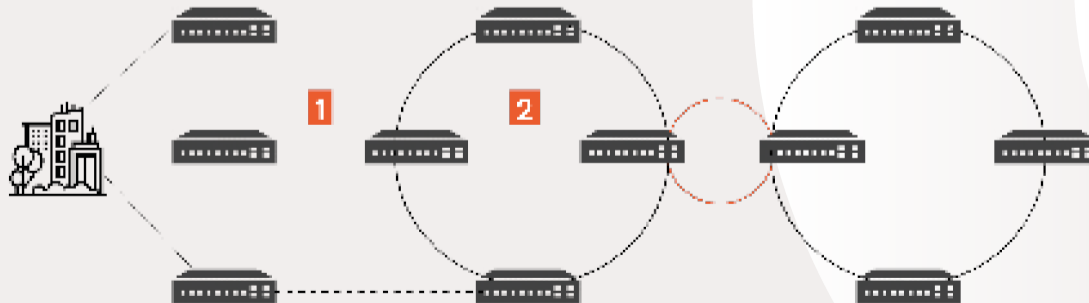

Business units

Aggregation networks S9600-56DX



The aggregation systems delivered by the partnership between Padtec and **UfiSpace** use switching techniques and advanced routing, to aggregate traffic from multiple access points, effectively directing you to the highest capacity aggregation nodes.

- 8 doors QSFP-DD 40/100/400G
- 48 doors QSFP28 de 40/100G
- 4 doors 1/10/25G SFP28
- 4,8 Tb/s switching capacity

Network Operating Systems

The functionalities are enabled through **OcNOS (IPInfusion software)**.

Funcionalidades:

- Routing (Layer 3)
- Multiprotocol Label Switching (MPLS)
- Layer 2 VPN (L2VPN)
- Layer 3 VPN (L3VPN)
- Virtual Extensible LAN (VxLAN)
- Segment Routing (SR)

Products

Enterprise



Switches

Complete family of switches with L2, L2 Lite, and L3 features, ranging from 5 to 48 ports. Using EdgeCOS, Edgeworks' operating system, we have access to a wide range of functionalities such as VLAN, QinQ, PoE, IPv4, and IPv6, among others, making these devices ideal for corporate solutions.

Business units

Access Point

EAP101, OAP101, EAP105



We provide complete and integrated Wi-Fi solutions for complex environments, including enterprises, MSPs, ISPs, and telecom operators, covering all aspects of network infrastructure and Wi-Fi 5/6/7 applications and advanced technologies such as OpenWiFi, ensuring reliability, high performance, flexibility, and excellent cost-effectiveness.

Topology

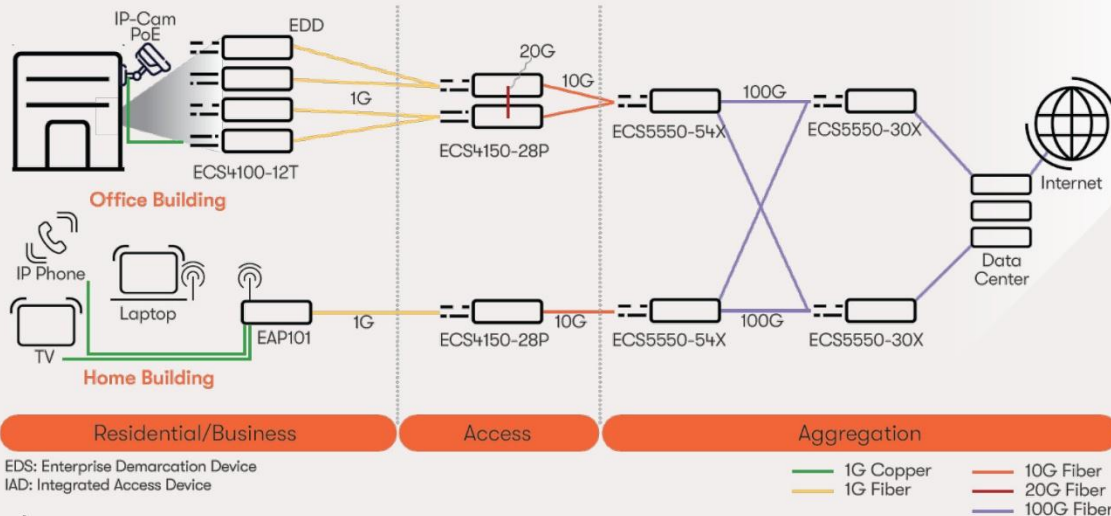

Key Features

- 
 Layer 2
 Layer 2+
 Layer 3
- 
 PoE Ports
- 
 EdgeCOS™
 EMBEDDED IN-HOUSE OPERATING SYSTEM
- 
 Multi-gigabit Ethernet
- 
 Full Control
- 
 Wi-Fi 5/6/7
- 
 No Vendor Lock-In
- 
 Enterprise-Grade Wireless Security
- 
 OpenWiFi
TELECOM INFRA PROJECT



Products

Enterprise



L3 Switch-10G (DL) L2+/Lite L3 10G Ethernet Switch

Designed for carriers, enterprises, and small data centers, the ECS5550 series offers high performance with simplified management. It supports IPv6, security, multicast, and advanced QoS, ensuring efficiency and high availability.

- 24/48 10GbE SFP+ ports
- 6 x 100GbE uplinks
- Support for IPv6, security, and multicast
- Advanced QoS



L3 Switch-1G/2.5G (DL) L3 Gigabit Ethernet Aggregation

Ideal for corporate environments, SMBs, and campus networks, the ECS4650-54P PoE switch delivers high performance in access and aggregation. With IoT support, it provides up to 90W per port and ensures efficient connectivity at the cloud edge.

- 48 Gigabit Ethernet PoE ports
- 6 x 25G SFP28 uplinks
- Up to 90W per port
- Support for enterprise, SMB, and IoT applications

Business units



L2 Switch-10G(DL) L2+/Lite L3 10G Multi-Gigabit

Designed for SMB networks, the ECS5500-12P switch functions as a compact, high-performance core switch. It ensures 10G connectivity with flexible uplink options.

- 8 x 10GBASE-T ports
- 2 x 10G SFP+ ports
- 2 x 10GBASE-T uplinks
- Ideal for SMB networks



Products

Enterprise

Business units

L2 Switch-2.5G(DL)

L2+/Lite L3 2.5G Multi-G Ethernet Switch



Versatile and high-performance, the ECS4155-30P switch is ideal for ISPs and MSOs in multi-Gigabit access and aggregation applications.

- 24 1/2.5G ports
- 6 1/10/25G uplink ports
- Access and aggregation support
- Suitable for ISPs and MSOs

2.5G L2 ULTRA POE SWITCH

The ECS4125-10P switch is a 2.5 Gigabit PoE access solution, ideal for SMB, enterprise, and campus networks. It provides efficient connectivity with 10G uplinks.

- 8 x 2.5 Gigabit Ethernet PoE ports
- 2 x 10G uplink ports
- Ideal for SMBs, enterprises, and campus networks



L2 Switch-All 1G(UL/DL)

L2+/L3 LITE GIGABIT ETHERNET ACCESS



The ECS4100-12T switch is ideal for ISPs and MSOs providing triple-play services to residential users, ensuring connectivity of up to 1 Gigabit of bandwidth.

- 8 Gigabit Ethernet ports
- 2 Combo Gigabit ports
- 2 x 100/1000 SFP ports
- Supports triple-play services



Products

Enterprise

Business units



L2 Switch-1G(DL) L2+/L3 LITE GIGABIT ETHERNET SWITCH

The ECS4150-28P switch is a PoE solution that delivers up to 30W per port, ideal for powering access points, VoIP phones, surveillance cameras, and IoT devices without individual power sources.

- 4 10G SFP+ ports
- 24 1G RJ45 PoE+ Ethernet ports
- Power up to 30W per port
- Compatible with access points, VoIP, cameras, and IoT
- Connectivity via Cat 5 UTP cables

L2+ GIGABIT ETHERNET ACCESS / AGGREGATION SWITCH WITH 4 10G UPLINKS

The ECS4120-28Fv2 switch is a high-performance Layer 2+ managed solution, ideal for environments that require high switching capacity and flexible uplinks.

- 20 GE SFP+ ports compatible with DDM
- 4 Combo Gigabit (4CG) ports
- 4 x 10G SFP+ ports
- Switching capacity of 128 Gbps



COMPACT SIZE, L2+/L3 LITE GIGABIT ETHERNET SWITCH

The ECS4130-28T-DC switch is ideal for ISPs and MSOs providing triple-play services to residential users, ensuring connectivity of up to 1 Gigabit of bandwidth.

- 28 Gigabit Ethernet ports
- 4 x 10G SFP uplinks
- Supports triple-play services
- Recommended for ISPs and MSOs



Products

Enterprise

Business units



Wi-Fi 7 AP

Indoor Wi-Fi 7 Access Point

The EAP105 is a corporate Wi-Fi 7 access point designed to deliver high performance, low latency, and high-density operation. It supports MLO, 2x2x2:2 MU-MIMO, and integrates Bluetooth Low Energy and ZigBee for value-added applications.

- Simultaneous tri-band, 320 MHz channel
- Aggregated data rate up to 9.34 Gbps
- 2x2x2:2 MU-MIMO
- Supports ecCLOUD / EWS/VEWS controllers
- Integrated BLE and ZigBee



Outdoor Wi-Fi 6 Access Point

The OAP101 access point is an enterprise-grade outdoor device with dual-band Wi-Fi 6, designed for outdoor and industrial environments with IP68 protection and a corrosion-resistant housing.

- 2x2:2 MU-MIMO
- Up to 3 Gbps
- BLE radio (iBeacon and Matter)
- Standalone or managed
- For outdoor and industrial use detection



Wi-Fi 7 AP

Indoor Wi-Fi 7 Access Point

The EAP101 access point is an enterprise-grade indoor device with simultaneous dual-band Wi-Fi 6, ideal for environments that demand high performance and reliable connectivity.

- 2x2:2 MU-MIMO
- Up to 1.7 Gbps
- BLE radio (iBeacon and presence)
- Standalone mode or managed via ecCLOUD
- Enterprise and high-density



Products

Business units

QSFP-DD Transceivers

Now, DWDM extends to routers and switches.

Padtec launches the 400G QSFP-DD module, a high-density pluggable solution compatible with switches and routers from various manufacturers. Ideal for 100G to 400G transmissions, this module is perfect for ROADMs systems, simplifying networks and reducing costs. Following the OpenZR+ standard, it offers high performance and interoperability, making it efficient for DCI, regional, and long-distance applications.

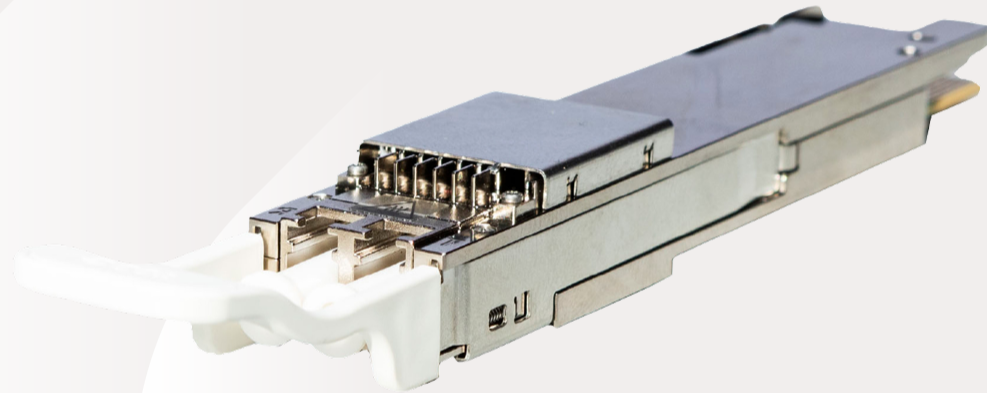



Products

Business units

Coherent Pluggable QSFP-DD 400G Ultra-Long Haul

The QSFP-DD 400G ULH is the first compact module on the market that enables 400G channels in DWDM networks with ultra-long-haul reach (≈ 2000 km in terrestrial networks and over 3000 km in submarine networks).

- 3 nm Gen120C DSP
- Coherent and tunable across the entire C+ band
- Standard form factor for routers with 400G ports
- Compatible with the power consumption and thermal dissipation of current-generation equipment with 400G ports (transponders, switches, and routers)

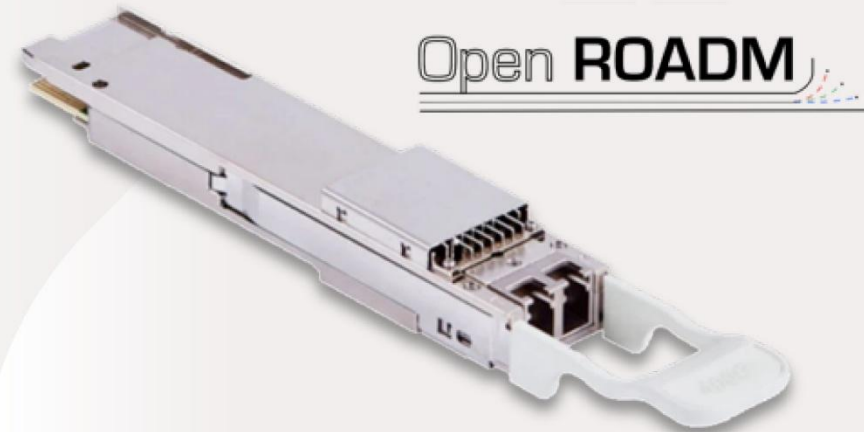



Products

Business units

Grey Transceivers Line

Padtec's Grey Transceivers line is an important complement to connectivity solutions between network equipment, covering both Layer 3 and DWDM environments. Developed with high-quality components, Padtec's pluggable transceivers are rigorously tested under each optic's limit scenarios, ensuring quality and robustness in their applications.

Key features:

Broad portfolio, addressing a wide range of interconnection demands

- From low data rates up to 400G/800G
- All standard market form factors
- Multiple optical standards, including extended-reach options

Guaranteed compatibility

- Compatible with a wide range of market-leading switches and routers, as well as Padtec's own equipment

Padtec support you already know

- Support from Padtec teams from the selection of the most suitable transceiver for each requirement through activation and any required module coding for specific compatibility





Products

Business units

LightPad OTDR Platform Optical Time-Domain Reflectometer

Monitoring, in real time, the status of your network.

The latest generation product, which is part of VIAMI's OTDR OTU-5000 series, remotely and automatically monitors the integrity of optical fibers.

- Unit with 3 slots for OTDR or WDM filters
- Number of fibers monitored: 4, 8 or 16
- Low power consumption (10W)
- Range of ~120 km (Dynamic Range: 39 dB)
- Monitoring of active or dark fibers
- Network operating band 1260 nm to 1580
- Graphical interface with conventional OTDR traces



Monitoring Software

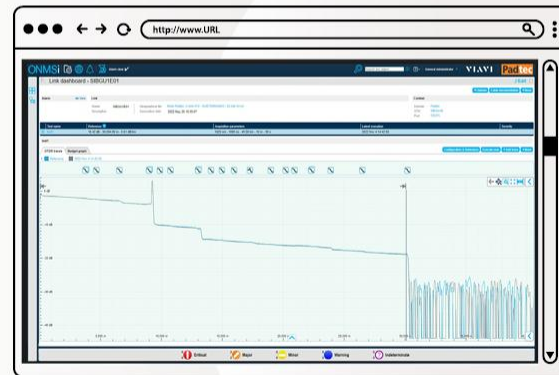

Monitoring chart example

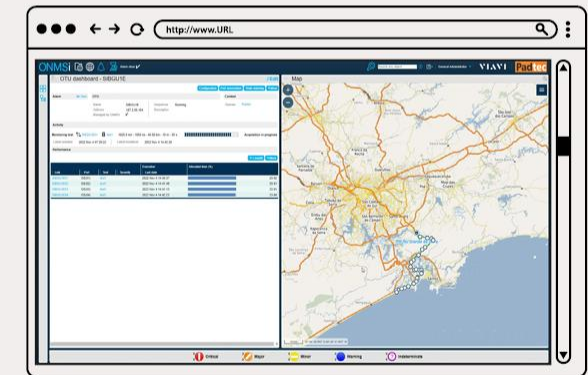



Products

Business units

Padtec NMS+

It's never been easier to manage your network

Comprehensive web management platform for DWDM networks.

- Web interface for board management
- New platform administration tools
- Supports high availability platforms
- Graphical interface for managing geolocated networks
- Addition of new provisioning features and restoration services
- External authentication support
- Displays a list of correlated alarms
- Web based

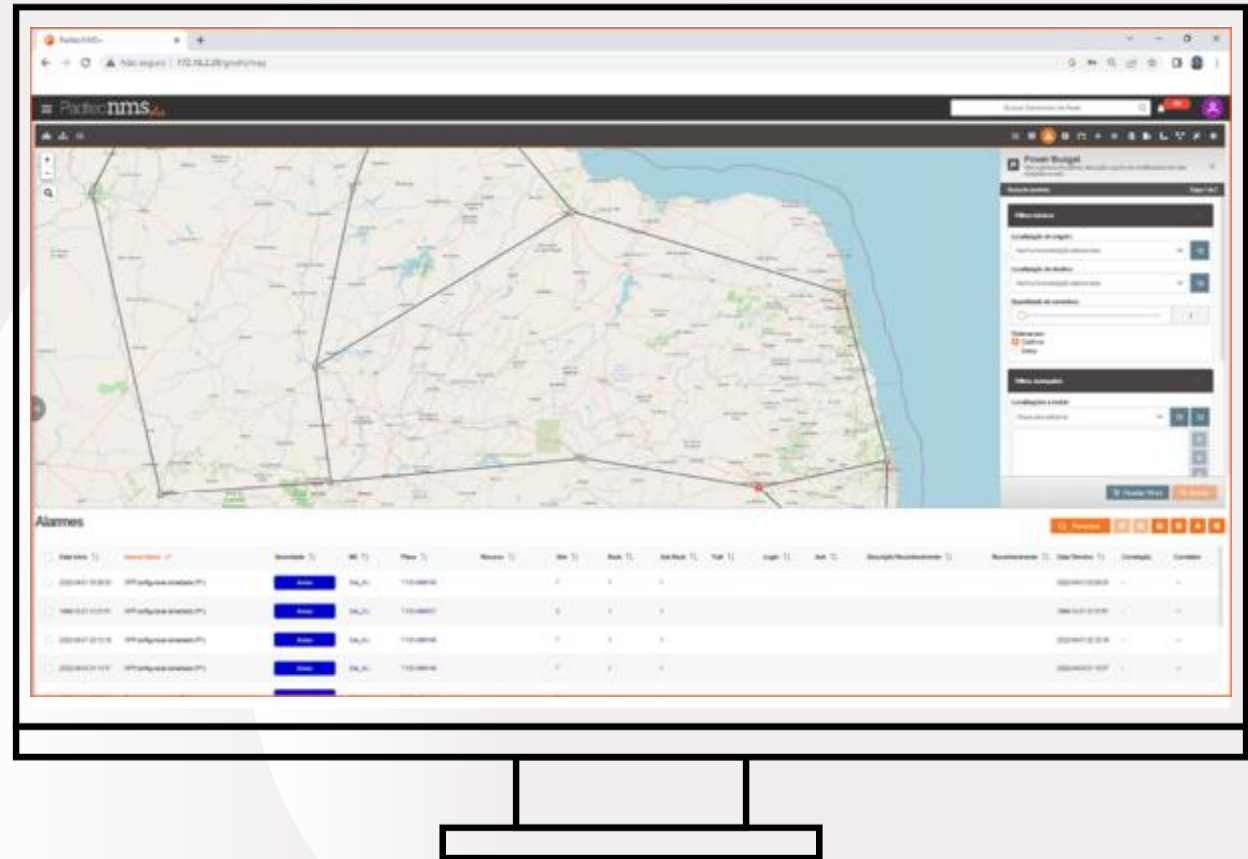



Sub Cables Full Turnkey

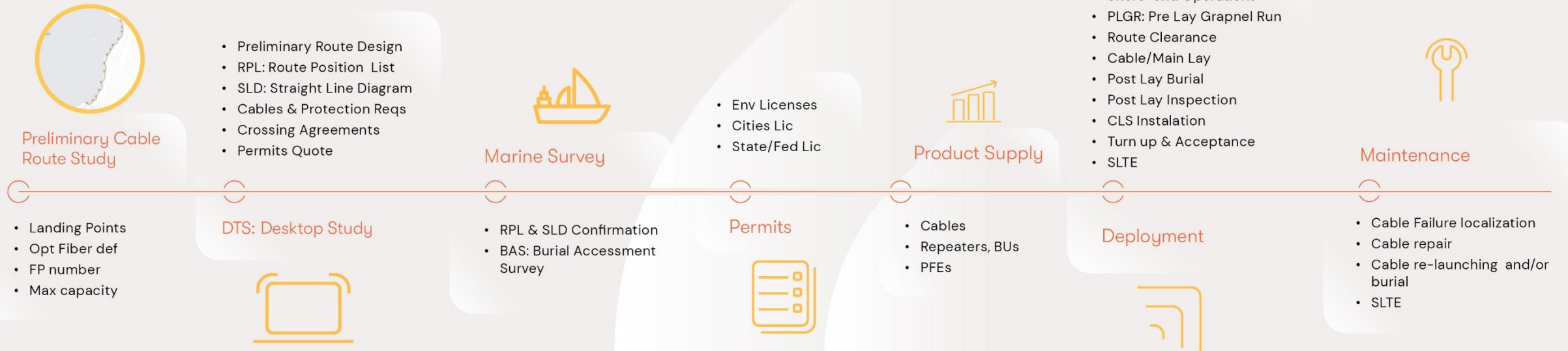



Services

Business units



Network Operation and Maintenance

- More than 40 MCs (Maintenance Centers) throughout Brazil, Argentina and Colombia;
- Four-hour service agreements (SLA) for the start of service in any section of a monitored network.



Network Management (NOC)

Padtec is always with you.

To fully monitor and manage routes, built with different technologies, in real time, Padtec also offers network operation and maintenance services from its Network Operations Center (or NOC).

- 24x7 operation;
- Performance Reports;
- Real-time monitoring.



Services

Business units

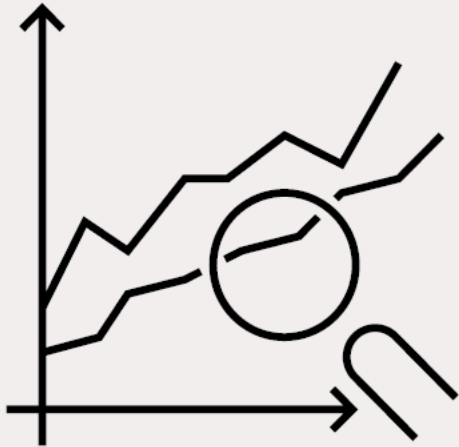

Characterization

For systems already in operation, the fiber characterization service helps plan expansions or even identify bottlenecks that are affecting the network's competitiveness.

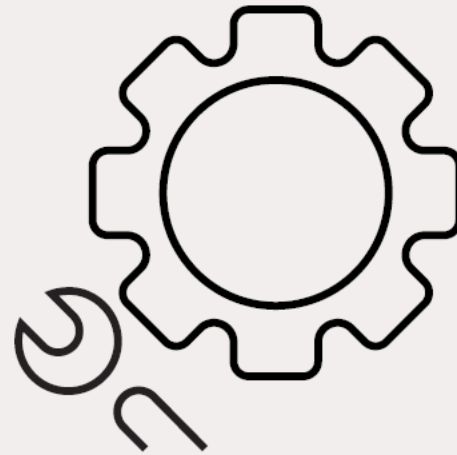

Spaas - Spare Part as a Service

Service for contracting spare parts for immediate replacement in cases of original equipment failure.



Services

Business units

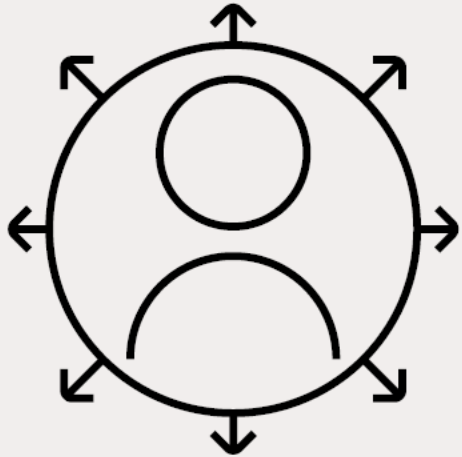

Fiber Supervision

Through its NOC, Padtec offers the supervision of both the monitoring systems and the fiber itself, providing information on degradation events, and precise geolocation of faults, in addition to attenuation history.

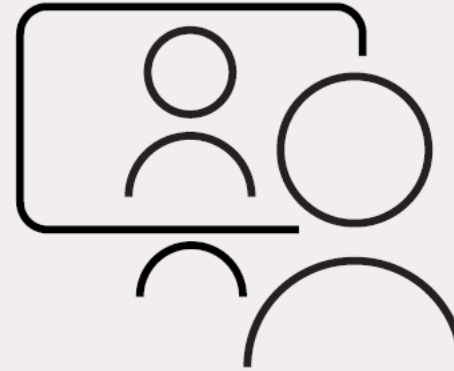

Training center

Basic and advanced modules for entry level and ongoing training.

Padtec's varied training portfolio includes theoretical courses in the areas of network planning and engineering and practical courses in the areas of operation and maintenance of DWDM networks.



Digital Solutions

Business units

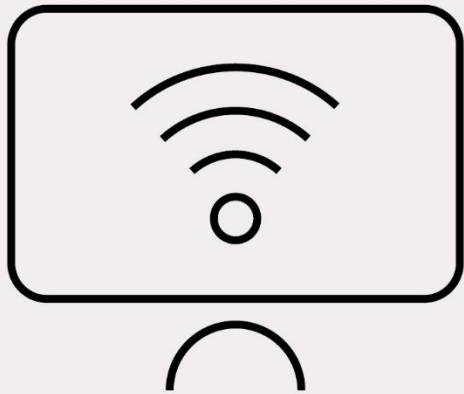

Smart Site

Monitor your site from anywhere: with the service, operators and ISPs can remotely monitor and control the elements that make up the infrastructure of their network environments in real-time.

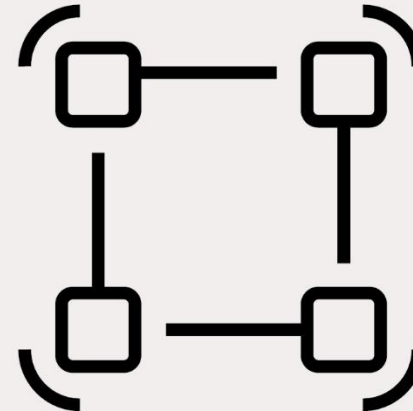

Smart Workspot

Developed in-house, the software enables integrated management of teams and response times, and can be customized for each operation. The Smart Workspot includes an app with offline access, ensuring productivity and data updates even in remote locations or areas with limited connectivity.



Digital Solutions

Business units

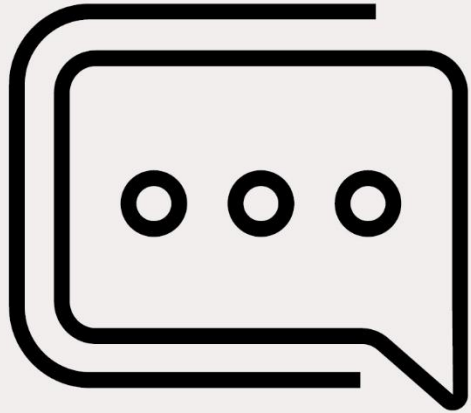

InovaTEC

Padtec, through InovaTEC, offers consultancy services to transform the telecommunications sector with innovative digital solutions. InovaTEC develops customized strategies, enhancing efficiency and sustainability with a flexible and agile approach that anticipates future demands.



Services



Network Operation and Maintenance

- More than 40 MCs (Maintenance Centers) throughout Brazil, Argentina and Colombia;
- Four-hour service agreements (SLA) for the start of service in any section of a monitored network.



Network Management

Padtec is always with you.

To fully monitor and manage routes, built with different technologies, in real time, Padtec also offers network operation and maintenance services from its Network Operations Center (or NOC).

- 24x7 operation;
- Performance Reports;
- Real-time monitoring.



Characterization

For systems already in operation, the fiber characterization service helps plan expansions or even identify bottlenecks that are affecting the network's competitiveness.



Spaas – Spare Part as a Service

Service for contracting spare parts for immediate replacement in cases of original equipment failure.



Fiber Supervision

Through its NOC, Padtec offers the supervision of both the monitoring systems and the fiber itself, providing information on degradation events, and precise geolocation of faults, in addition to attenuation history.



Training center

Basic and advanced modules for entry level and ongoing training.

Padtec's varied training portfolio includes theoretical courses in the areas of network planning and engineering and practical courses in the areas of operation and maintenance of DWDM networks.



Digital Solutions



Smart Site

Monitor your site from anywhere: with the service, operators and ISPs can remotely monitor and control the elements that make up the infrastructure of their network environments in real-time.



InovaTEC

Padtec, through InovaTEC, offers consultancy services to transform the telecommunications sector with innovative digital solutions. InovaTEC develops customized strategies, enhancing efficiency and sustainability with a flexible and agile approach that anticipates future demands.

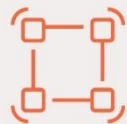

Smart Workspot

Developed in-house, the software enables integrated management of teams and response times, and can be customized for each operation. The Smart Workspot includes an app with offline access, ensuring productivity and data updates even in remote locations or areas with limited connectivity.

Business units



Results 2025



Net
Revenue

R\$ 291.9 mi



Revenues from the
international market

R\$ 80.7 mi



Gross
Margin

35.8%



R&D

R\$ 20.8 mi

7% of Net Revenue



EBITDA

R\$ 42.7 mi



Results

Consistent balance of net revenue

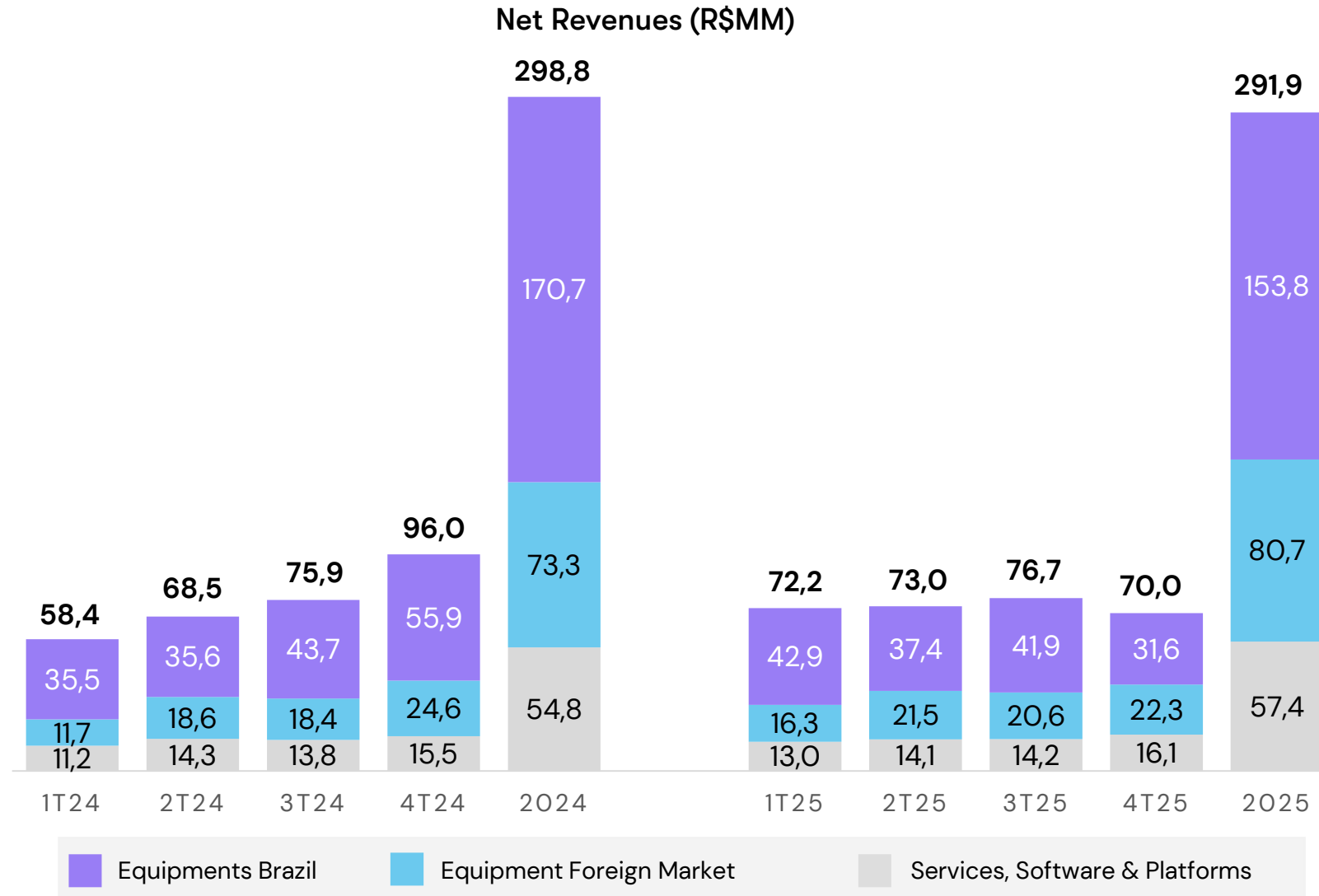

Results

Generating profits through cost, inventory, and logistics optimization.

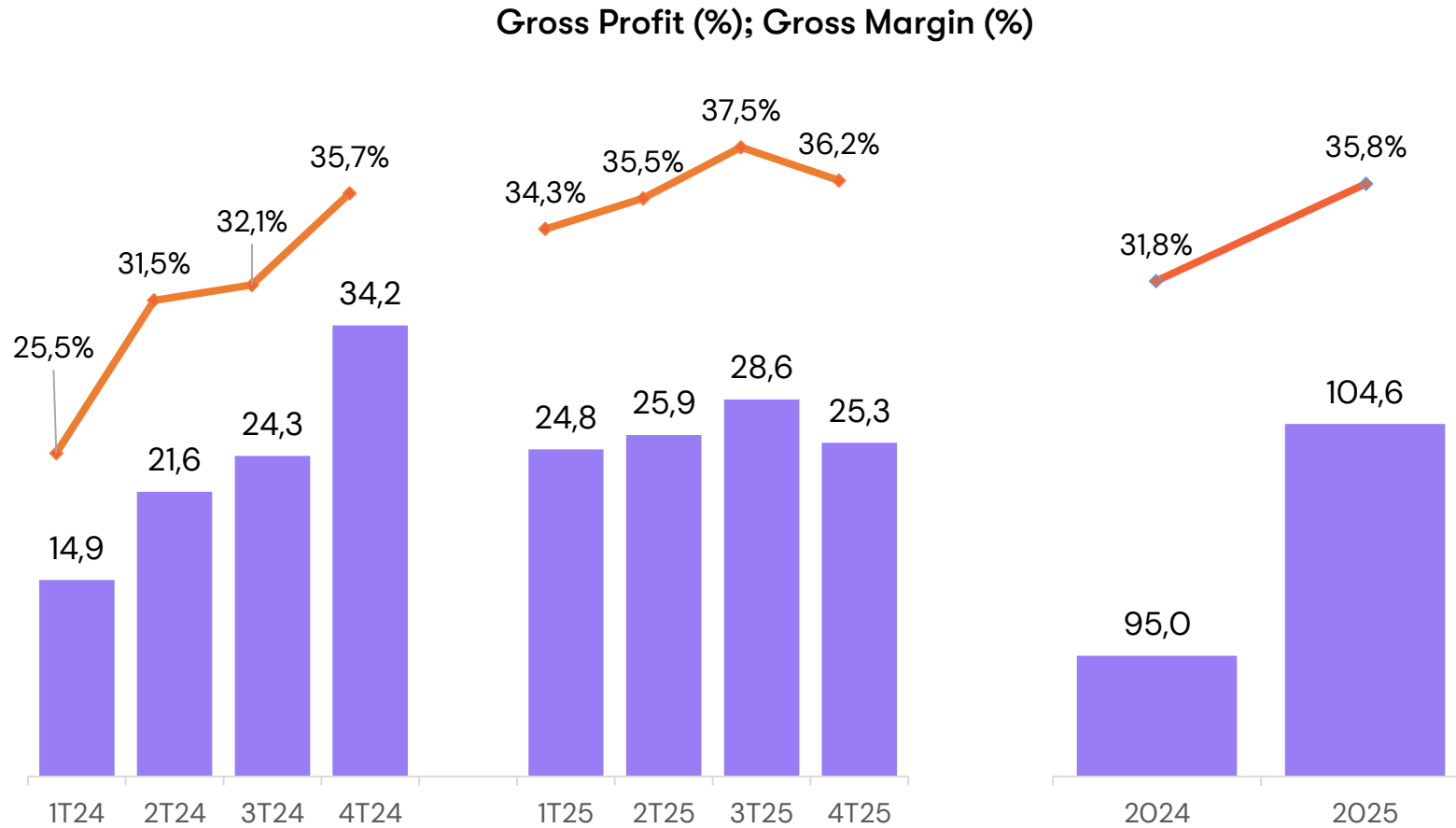

Results

Reaffirming our commitment to sustainable efficiency and the continuous creation of shareholder value.

EBITDA (R\$MM); EBITDA margin (%)

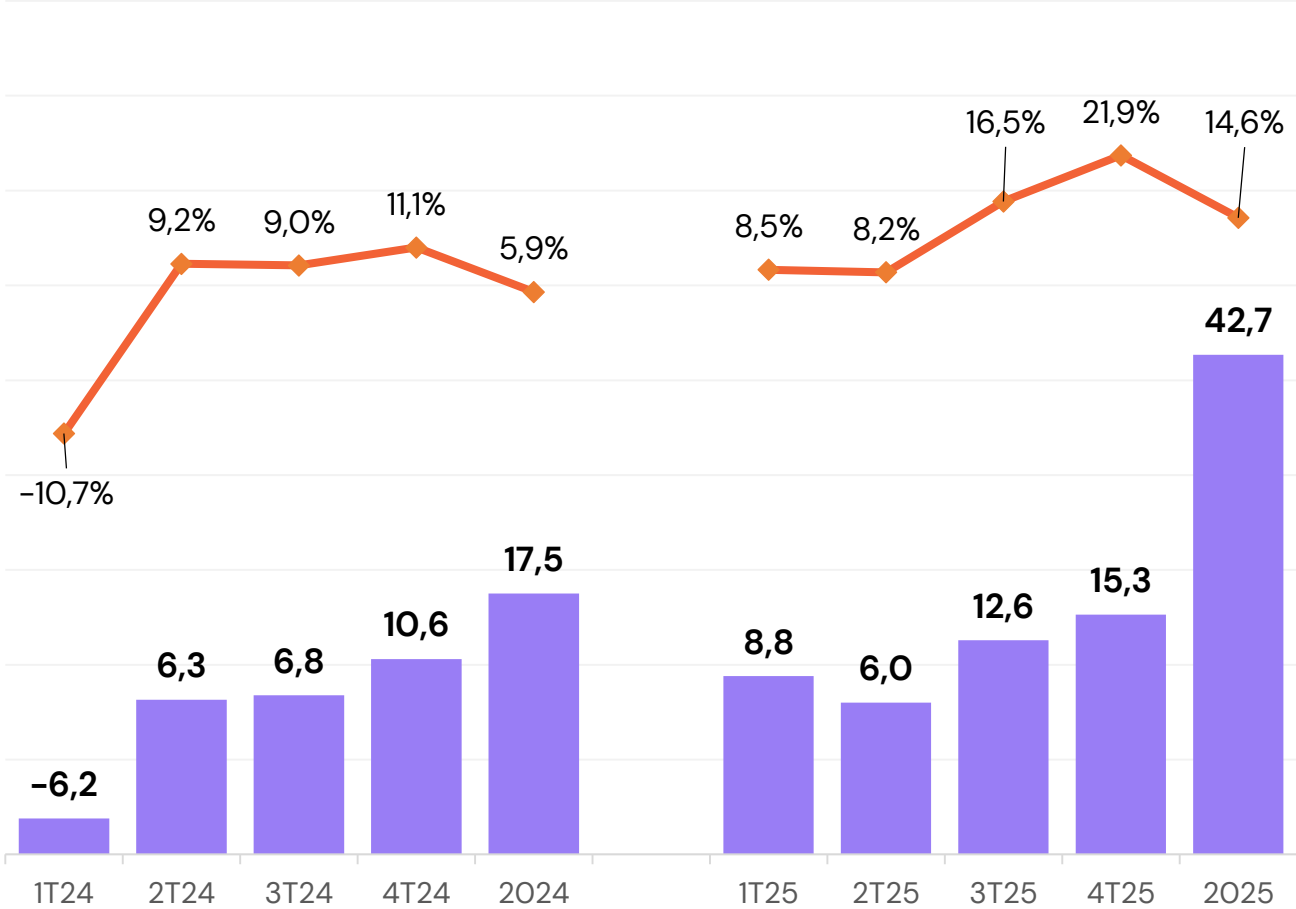

Results

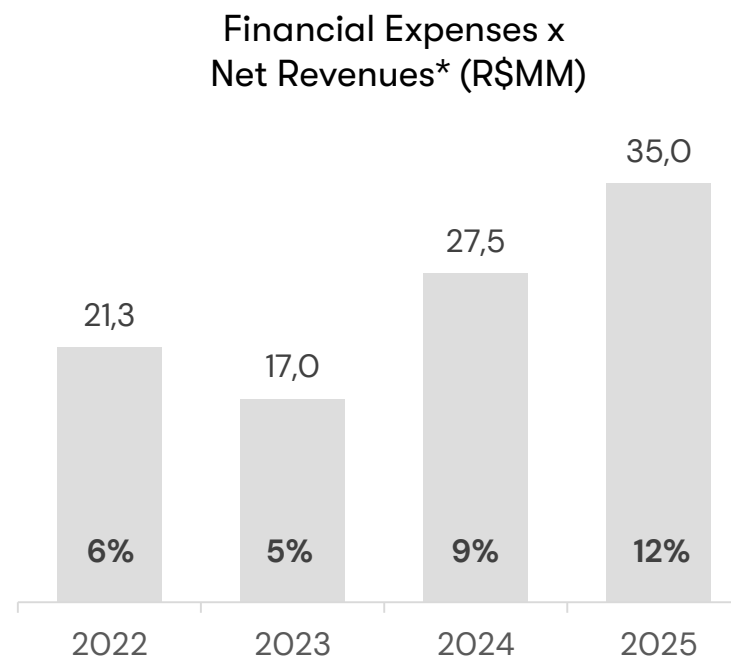
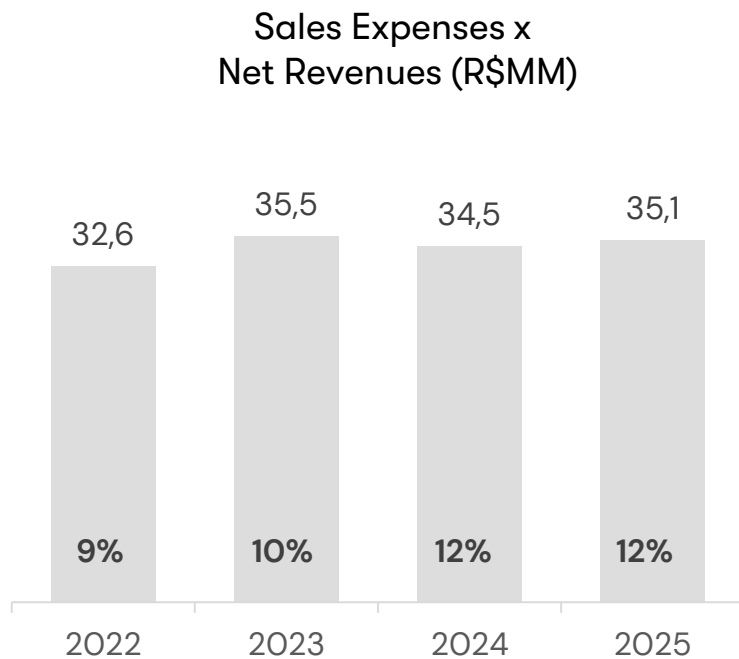
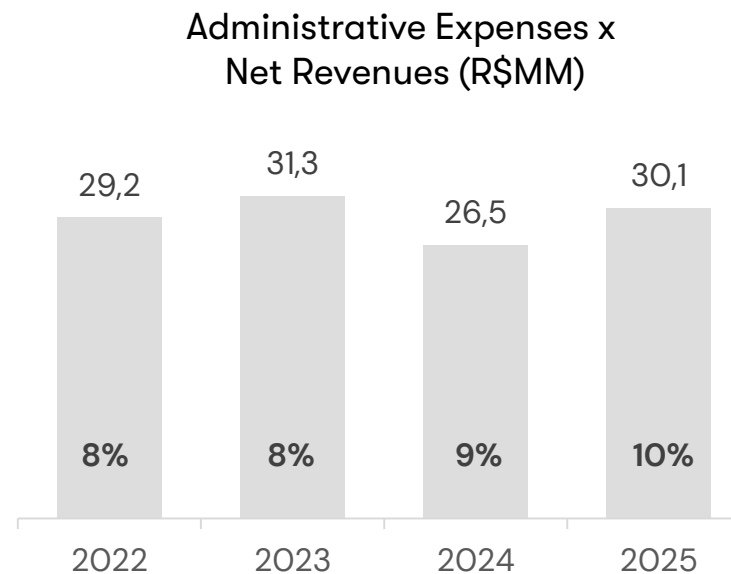
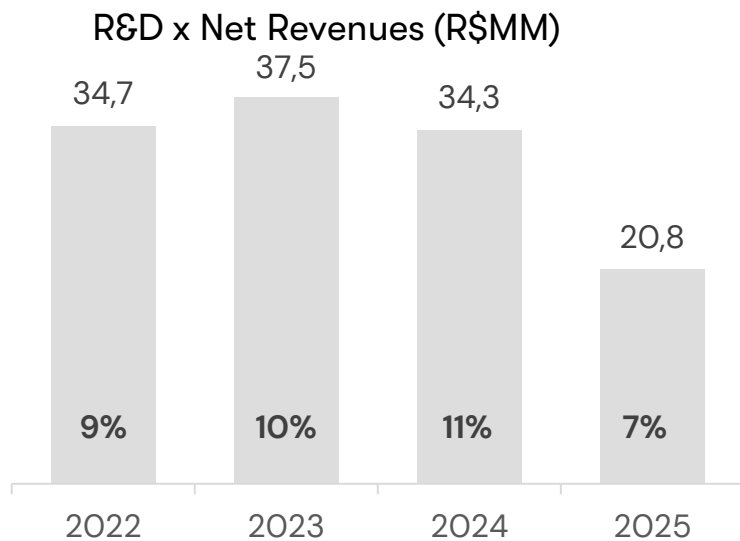

*Não considera variação cambial.

Results

Long-term and secure debt structure for restructuring/repositioning.

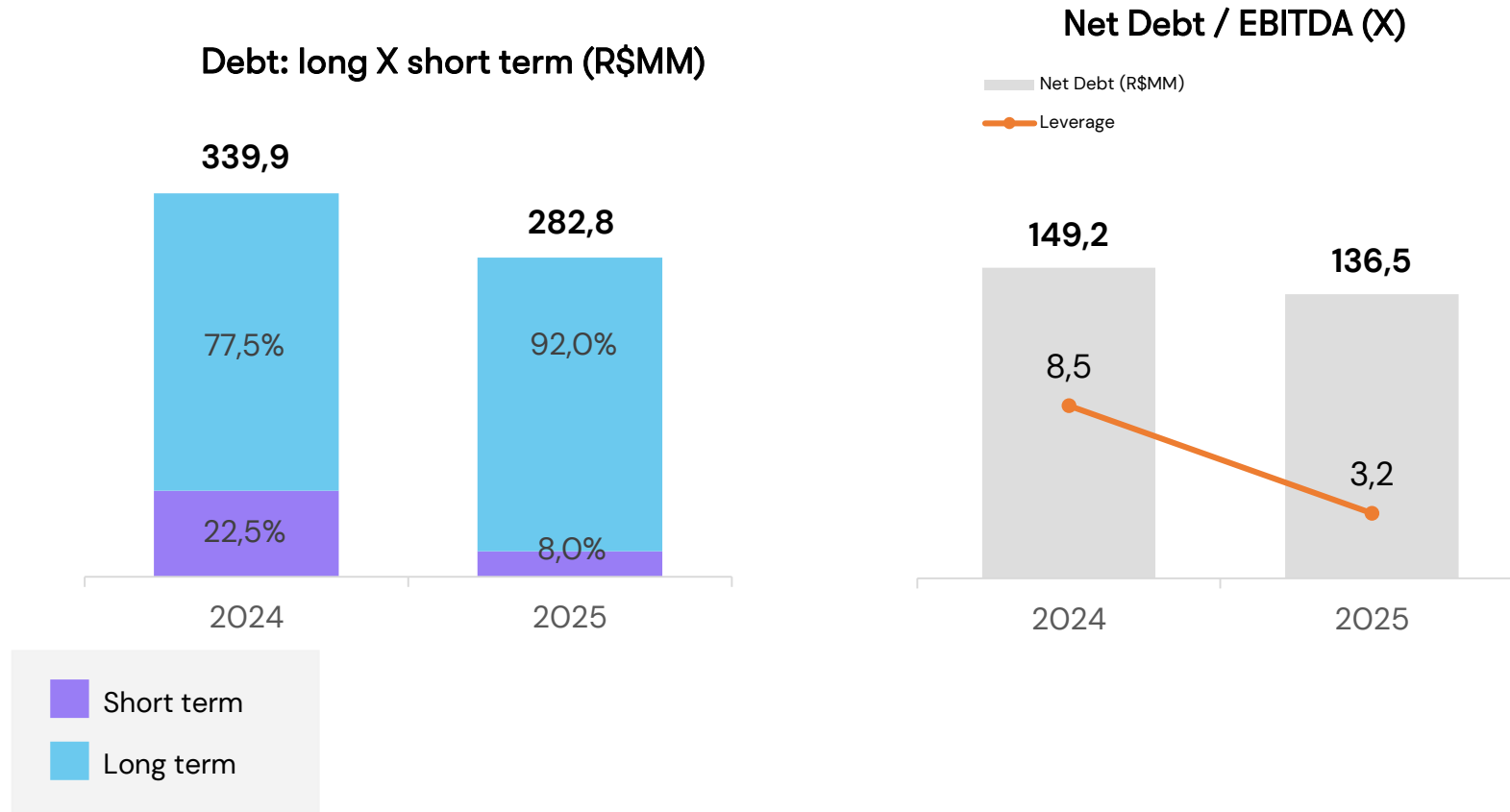

- Cash resources allow for greater liquidity availability and room to support growth options.
- 92.0% in long-term obligations, average cost of funding: **9.3%** p.a. in Q4 2025.
- Average repayment term of 10 years.

Results

Net debt impacted by high interest rates.

Debt Evolution (R\$MM)

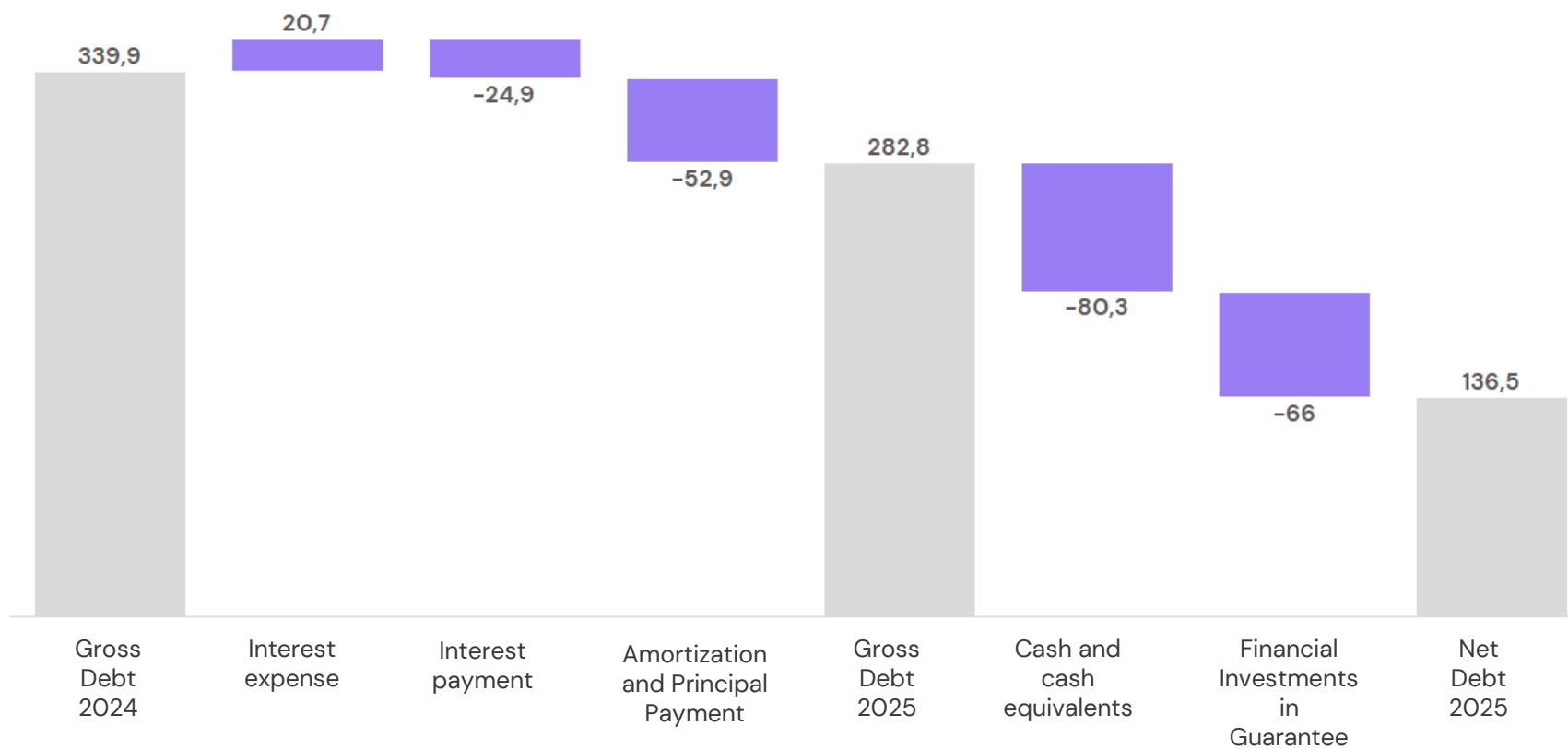



padtec.com

padtec

transform

Driving connections to create new realities

revolutionize